

UL-listed with PV Inverters



UL-listed with PV Modules



North American Distributors



TS4 System Architectures for Rapid Shutdown

The Only UL-Certified Multivendor Rapid Shutdown MLPE Solution for Residential and C&I

The Most Cost-Effective Rapid Shutdown Solution

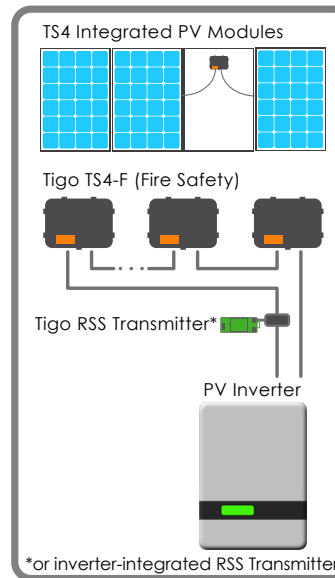

Rapid Shutdown with Module-Level Monitoring and Optimization

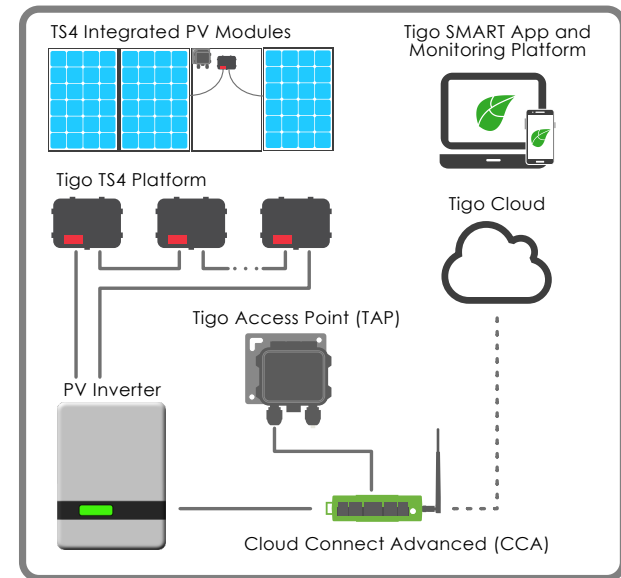

Fire Safety





Safety



Optimization



Rapid Shutdown with Power Line Communication



| TS4-A Advanced Add-on | SKU |
|--|--------------|
| TS4-A-F (Fire Safety), 1500V UL / 1000V TÜV, 1.2M Cable, MC4  | 458-00252-32 |
| TS4-A-2F (Fire Safety), 1500V UL, 1.2M Cable, MC4  | 484-00252-12 |
| TS4-A-2F (Fire Safety), 1500V UL, 2.2M Cable, MC4  | 484-00252-22 |







Rapid Shutdown with Module-Level Monitoring



| TS4-A Advanced Add-on | SKU |
|---|--------------|
| TS4-A-O (Optimization), 1500V UL / 1000V TÜV, 1.2M Cable, MC4  | 451-00252-32 |
| TS4-A-S (Safety), 1500V UL / 1000V TÜV, 1.2M Cable, MC4  | 456-00252-32 |







RSS Transmitter and Accessories



| Power Line Communication | SKU |
|---|--------------|
| Single Core (150A) RSS DIN Rail Transmitter (no power supply or enclosure)  | 490-00000-10 |
| Dual Core (300A) RSS DIN Rail Transmitter (no power supply or enclosure)  | 490-00000-20 |
| Single Core (100A) RSS DIN Rail Transmitter Kit, 120/240VAC power supply, Outdoor Enclosure  | 492-00000-10 |
| Dual Core (200A) RSS DIN Rail Transmitter Kit, 120/240VAC power supply, Outdoor Enclosure  | 492-00000-20 |
| Commercial Dual Core RSS DIN Rail Transmitter, 480/277VAC power supply (no enclosure)  | 493-00000-20 |
| RSS Signal Detector (includes 4 x AA batteries)  | 400-00900-00 |

Communication Accessories for Module-Level Monitoring







| Wireless Communication | SKU |
|--|--------------|
| Cloud Connect Advanced (CCA) Standalone   | 346-00000-00 |
| Tigo Access Point (TAP)   | 158-00000-02 |
| CCA, TAP, DIN rail power supply, Outdoor Enclosure   | 348-00000-52 |

Inverters with Integrated RSS Transmitter Available





TS4 Feature Reference

| | Module-Level Optimization | Rapid Shutdown | Module-Level Monitoring | Selectively Deployable | Install with |
|--|---------------------------|----------------|-------------------------|------------------------|-----------------|
|  Optimization | ✓ | ✓ | ✓ | ✓ | CCA & TAP |
|  Safety | | ✓ | ✓ | ✓ | CCA & TAP |
|  Fire Safety | | ✓ | | | RSS Transmitter |
|  Monitoring | | | ✓ | ✓ | CCA & TAP |

TS4 Accessories

The Cloud Connect Advanced (CCA) is the data logger for the TS4 Flex MLPE platform and uses the Tigo Access Point (TAP) to communicate wirelessly with the TS4 units for monitoring and safety control.



Tigo's RSS (Rapid Shutdown System) Transmitter controls rapid shutdown for the TS4 Fire Safety (TS4-F) units.

